

Model: DGSNFSTCH55WH

Description: 55" Indoor Floor Standing Digital Signage

Scan QR code to visit
the product page:



Operating Instructions for Digital Signage

Note: Before using the product, please read the instructions carefully!

Do not attempt to disassemble this product. If the product does not work properly, please call our Customer Service Department at 1-844-221-3393.

Contents

Features	3
Safety Warnings and Precautions	3
Assembly and Connection	5
Packing List.....	5
Interfaces	6
Steps for Assembly.....	6
Steps for Assembly with Casters	7
Remote Control	8
Description of Basic Operation	9
Power on/Standby	9
About Launch Desktop.....	9
Description of Wallpaper Switch.....	10
File Manager	10
Local Settings	11
Status of Menu bar	12
DiViEx APP Introduction.....	12
System requirements	12
How to upload media files	12
Settings.....	14
Edit picture.....	14
Music.....	15
Factory Reset.....	16
Screen Rotation.....	17
Choose System Language.....	17
Technical Specifications.....	19
Troubleshooting.....	22
Cleaning and Maintenance.....	23
Names and Contents of Toxic and Hazardous Substances or Elements in the Product.....	24
FCC Compliance Notice.....	25

Features

1. Embedded with Android 7.1 smart operating system and unique UI design, bringing you a more convenient operation and better visual experience.
2. Support USB mouse and keyboard, realizing easy manipulation like a computer. Using a mouse for set up is recommended.
3. Built-in Wi-Fi module, high capacity memory and high capacity cache, making it smoother to watch 1080P HD movies and play big games.
4. High-quality LCD screen as the display, no flicker, low radiation, greatly reducing eye fatigue, eye protection, high brightness, high contrast, and wide viewing angle; ultra-fast response time greatly reduces ghosting of fast moving images.
5. Progressive image processing and industry-leading motion compensation technology improve the flickering and blurring in the edges of motion picture.
6. Dynamic contrast technology can significantly improve the clarity and contrast of various screens.
7. Multi-channel USB interfaces, supporting HD media streaming.





Safety Warnings and Precautions

Thank you for purchasing the high-performance multi-functional LED backlight Digital Signage from Displays2go. We have considered the factors to ensure personal safety in product design and have tested rigorously at the factory. However, improper installation and use may result in electric shock and fire. In order to safely use, maximize performance of the unit and extend the life of the product, please read and follow all instructions carefully before using the product.

Keep the instructions for future reference.

We strongly recommend using a surge protector, or a power strip with internal circuit breaker to prevent damages to the digital signage.

Symbol Legends:

-  **Warning: May cause personal injury or death**
-  **The operation is prohibited**
-  **Caution: May cause damage or property loss**
-  **The operation must be executed**

If any of the following occurs:

- Power outage or instable voltage.
- Abnormal sound or smell from the unit.
- AC power cord is damaged.
- Digital Signage is damaged due to drop, knock or impact.
- Any liquid or foreign matters fall into the enclosure.



Turn off the Digital Signage immediately, pull out the plug from the power outlet, and ask the authorized personnel for maintenance timely.

 **If coal gas or other flammable gas leaks, do not pull out the plug of the LCD Digital Signage or other electrical appliances; instead, turn off the gas valve immediately, and open the doors and windows quickly.**



- ⊘ ● Do not use power supply other than AC 110V, 60Hz.
- Cut off the power supply before connecting or disconnecting any cables.
- Do not place the Digital Signage on any instable positions, or else it may be damaged or cause fire.
- Do not place the Digital Signage in the positions such as:
 1. The environment subject to direct strong sunlight, moisture, extreme temperature or too much dust;
 2. The environment with flammable or explosive materials;
 3. The environment with flammable or corrosive gases;
- Do not use damaged or inappropriate power outlets, and ensure that the plugs and outlets contact properly.
- Do not let dust or metal deposits adhere to the plugs and outlets.
- Do not damage the power cords:
 1. Do not modify the power cords;
 2. Do not place heavy objects on the power cords;
 3. Keep the power cords away from heat source;
 4. Do not pull the cord to remove the plug.
- Do not connect too many plugs to one outlet in parallel, or else it may cause fire due to excessive power consumption.
- Do not approach the Digital Signage with open flame (e.g. a lighted candle), or else it may cause electric shock or fire.
- Do not put any sharp objects, metal or liquid into the vents or let them touch the signal terminals to avoid short circuit, product damage, and electric shock.
- The openings in the enclosure are designed for ventilation and cooling, to ensure long time reliable running of components inside the enclosure and prevent overheating. Do not block the openings when place the unit.

- ⊘ Do not touch the plugs with wet fingers, or else it will cause electric shock.

Do not use the Digital Signage in stormy weather, especially when there is lightning; instead, please disconnect the power and antenna plugs to avoid lightning strike.

- ⊘ Do not disassemble the Digital Signage without permission, or else it may cause electric shock or fire. Please ask qualified technician for repair.

 **CAUTION**

- Do not let children climb onto the Digital Signage.
- Keep the small parts away from children to prevent them from swallowing.
- If the Digital Signage won't be used for a long time, please turn it off and pull out the power plug.
- To adjust the position of the Digital Signage, please disconnect all power cords and move slowly to avoid tip over.
- Do not scratch or knock the LCD with hard object, or twist and squeeze the LCD.
- Do not turn on the unit immediately when it is moved from a place with low temperature to high temperature, or else it will cause condensation and malfunction.
- Before cleaning the Digital Signage, please pull out the power plug; wipe with soft cloth; do not use industrial chemicals; prevent foreign matters from entering the machine. Improper cleaning (such as cleaning solution, water) may damage the product, erase the printed information, and even cause damage of the components if fluid flows in, resulting in machine failure.
- If the unit displays the same screen for a long time or the moving picture has fixed text or icon, it will leave ghosting on the screen and won't disappear when the unit is turned off; it is normal and isn't covered by the warranty.
- The power of the Digital Signage can be cut off by pulling out the plug.
- If the LCD screen ruptures and the liquid splashes on the skin, please rinse for 15 minutes with clean water immediately, and consult your doctor.
- To carry the Digital Signage with hands, please grab and hold the edges; do not apply pressure on the panel.
- Use the Digital Signage properly: Use in proper lighting conditions; insufficient lighting or long time watching will impair your eyesight.
- When the plug or coupler is used as disconnection device, it should be easy to operate the device.
- Insert the plug into the outlet properly, or else it may cause sparks and fire.
- The technical specifications printed herein and on the packaging are subject to change without prior notice. The Manual may be slightly different from actual operation, and the latter is applicable.

Assembly and Connection

Packing List

Name	
1 Digital Signage	●
1 Remote Control	●
1 Operation Manual	●

Name	
1 Power Cord	●
1 Cleaning Kit	●
Two Keys	●

Note:

Contact local dealer if you have questions about the operation, debugging and connection of the unit; if the unit doesn't work normally, please cut off the power immediately and consult the dealer. The unit is class-A product, which may cause radio interference in living environment. In this case, please take feasible measures, and use power plug as the disconnection device.

Interfaces

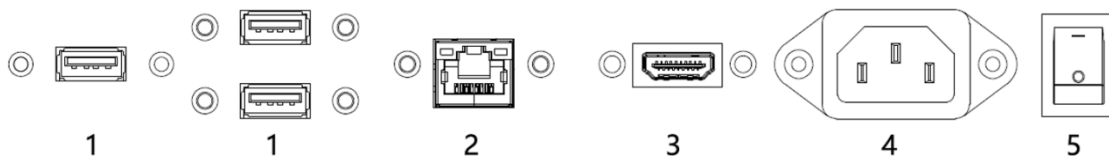

1. USB interface; 2. RJ45 interface(Ethernet); 3.HDMI input; 4.Power port; 5. On/Off button;
CAUTION: Disconnect the power plug before assembling or disassembling the unit!

Steps for Assembly

1. Open the top cover as shown in Fig. 2;
2. Remove EPE on both sides of the box as shown in Fig. 3;
3. Take out the base from the package as shown in Fig. 4;
4. Carefully lift out the unit as shown in Fig. 5 and place it on the shipping box (avoid scratching) (Fig. 6);
5. Assemble the base and the unit with dedicated screws using hex socket wrench as shown in Fig. 6.

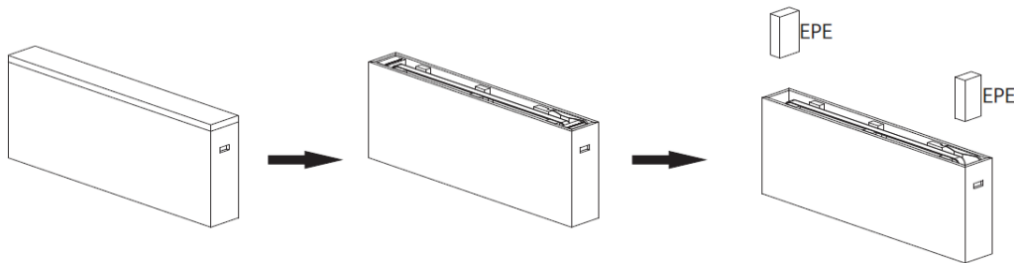

(Fig. 1)

(Fig. 2)

(Fig. 3)

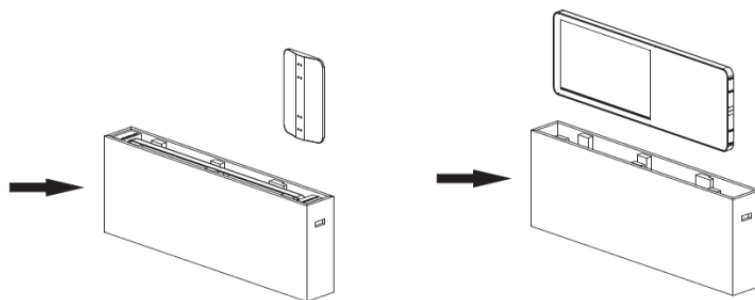

(Fig. 4)

(Fig. 5)

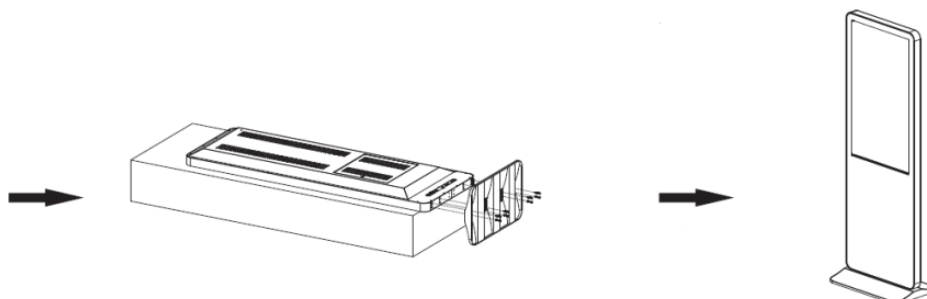

(Fig. 6)

(Fig. 7)

Steps for Assembly with Casters

1. To use this product as a mobile unit, install 4 casters to the metal base by threading them into the holes on the bottom of the base. Tighten all casters with a 14mm wrench.

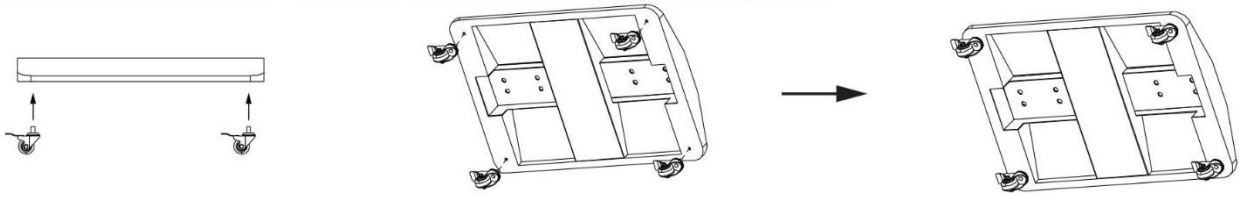

2. Connect the base and the digital poster with provided screws. Tighten all screws with an Allen wrench.

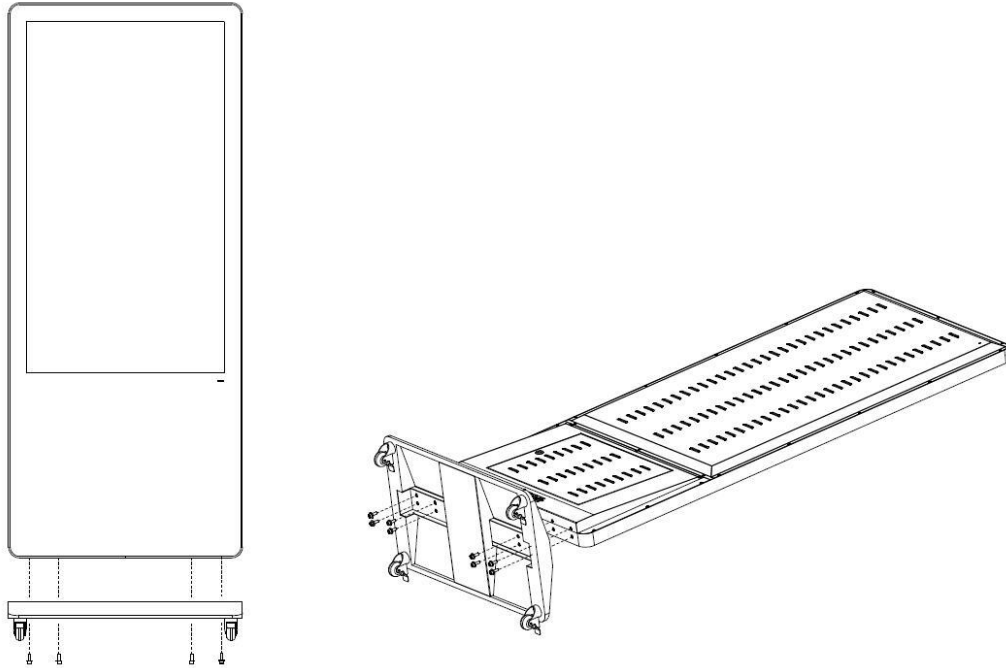

3. The assembly is finished:

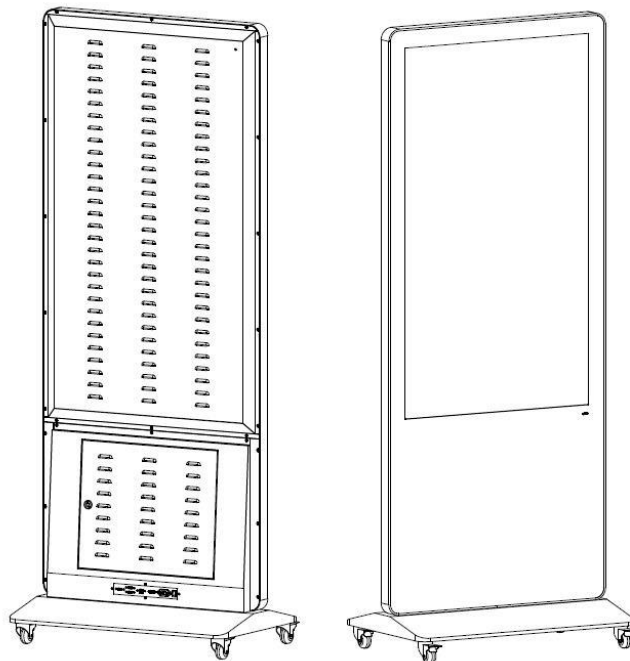

Remote Control

Installing batteries for the remote control:













Remove the battery cover and insert two AAA batteries (1.5V). Ensure that the battery polarity matches the “+”/“-” marks in the battery compartment of the remote control.

Precautions for using the remote control:

- Aim the remote control at the receiver window. Do not place any object between the remote control and the receiver window to avoid interference with the normal operation.
- Keep the remote control away from violent vibration. In addition, do not set or place the remote control in direct sunlight, or else the remote control may be deformed by heat.
- The remote control may be invalid when the receiver window of the unit is in direct sunlight or strong lighting; in this case, please adjust the angle of the lighting or the unit or approach the receiver window to use it.
- The distance of remote control will be shortened if the battery voltage is insufficient; in this case, please replace with new batteries; if the remote control won't be used for a long time or the batteries are run out, please take out the batteries to avoid corrosion due to battery leakage, which will damage the remote control.
- Do not use batteries of different types or mix new batteries with old ones. Always replace the batteries in pairs.
- Do not put the batteries in fire, or charge or disassemble them, or charge, short circuit, disassemble, heat or burn used batteries. Please dispose of waste batteries in accordance with local environmental regulations. Do not expose the batteries in overheated environments such as sunlight and fire.

Description of remote control buttons:



Button	Function
	Power switch
	To show the Source menu
	Mute
	Turn up the volume
	Turn down the volume
OK	Confirm selection
	To move the cursor up
	To move the cursor down
	To move the cursor left
	To move the cursor right
	Switching options
	Home button
	Go back to the parent menu
MENU	To show the main menu
SETUP	To set up OSD menu

Note: Press the SETUP button in the main interface to call out the OSD menu. After exiting the playback mode by pressing the STOP button, the playback will start according to the schedule next time.

Description of Basic Operation







Power on/Standby

Insert the power plug into the outlet. If the Digital Signage has the power switch button “I”, turn it on. If you press the switch button “O”, the Digital Signage enters standby state.

When powered on, enter “System Assistant” and press the “⏻” button on the remote control, and the Digital Signage enters standby state.

About Launch Desktop

Description of Desktop Icons

Icon	Function
	Main applications
	Back
	Home page
	Background applications
	Sound -
	Sound +
	Status bar hidden

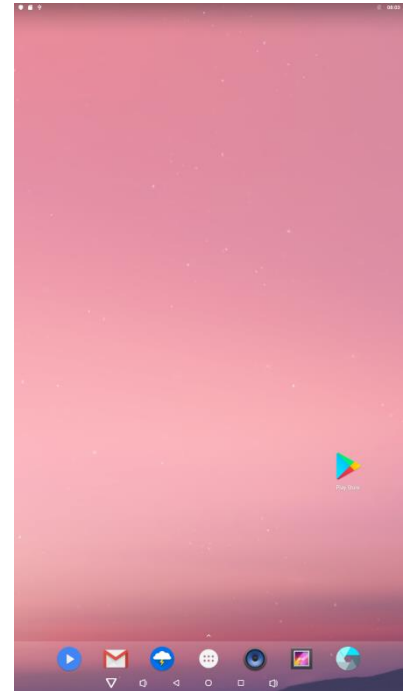

Description of Wallpaper Switch

We suggest using a mouse to change the wallpaper.

Connect a mouse with the digital panel through USB port, then follow the steps below:

1. click "Setting"
2. At the setting menu, click "Display"
3. At the Display setting menu, click "Gallery", or "Wallpaper"
4. Then select an image you would like to set up as background.
5. Confirm the selection by clicking "Set wallpaper".

File Manager

1. Click the Main Apps button "⋮" in the Home page to enter the "APPS" menu interface (Fig. 2);
2. Click the "Explorer" icon in the "APPS" menu interface (Fig. 2) and enter "Explorer" menu (Fig. 3);
3. Click options in the "Explorer" menu to read the files from different devices.

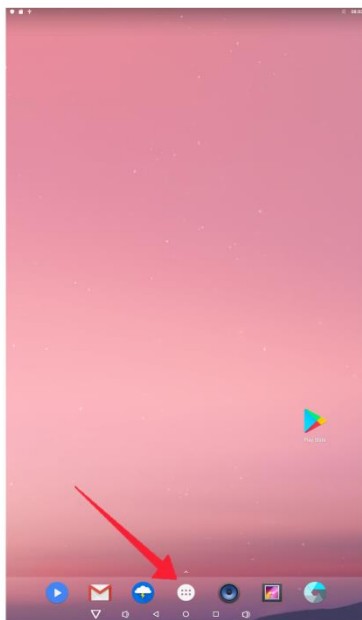

Fig. 1

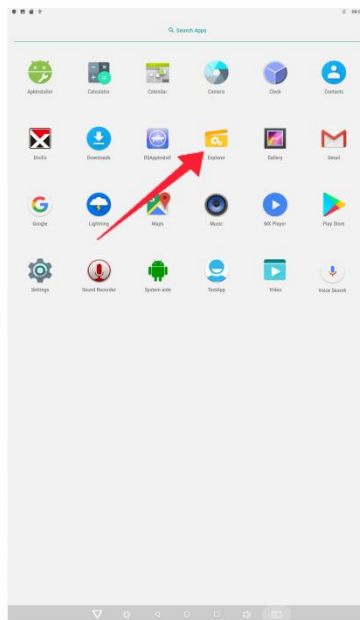

Fig. 2



Fig. 3

Local Settings

1. Click the Main Apps button “
- 2. Click the “Settings” icon in the “APPS” menu interface (Fig. 2) and enter “Wi-Fi” menu (Fig. 3);
- 3. Click options in the “Wi-Fi” menu and set up different options.

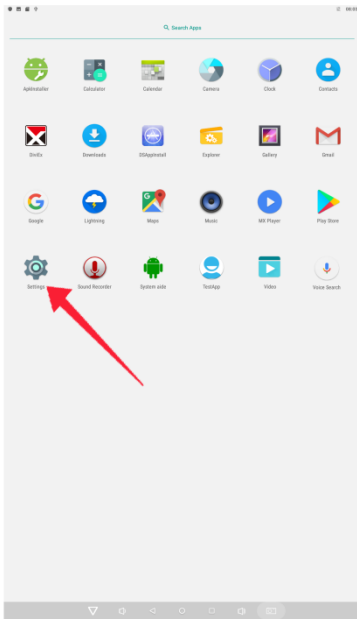

Fig. 1

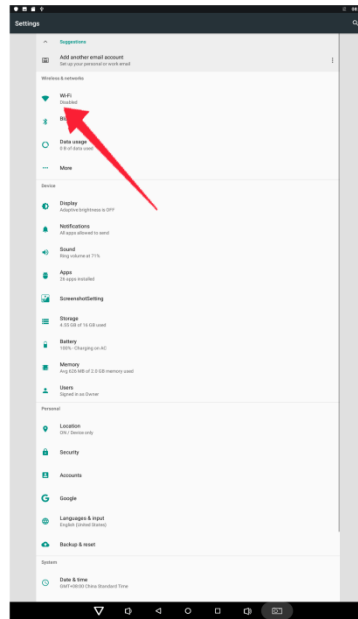

Fig. 2

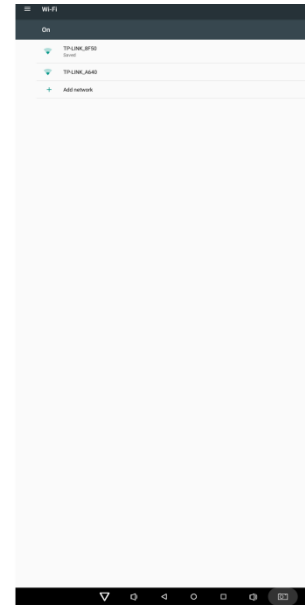



















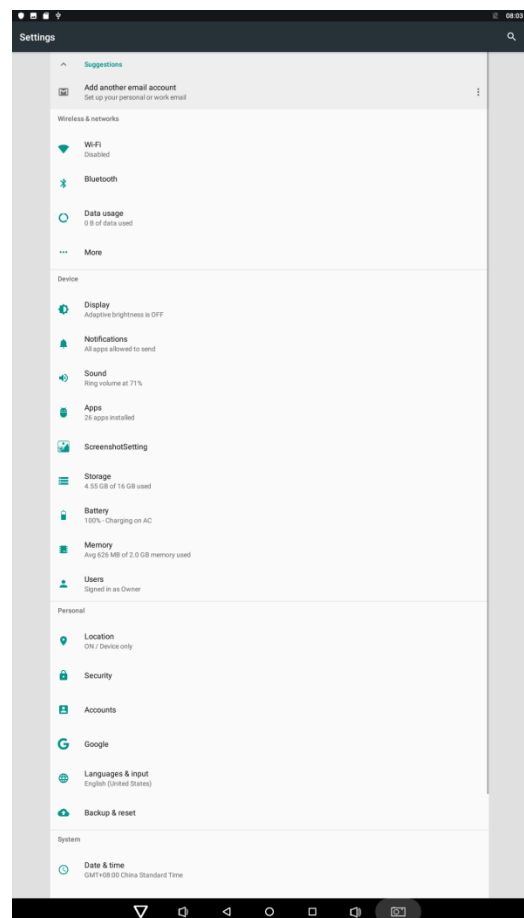

Fig. 3

Description of Settings Interface (shown on the right)

Icon	Function
	WIFI switch
	Bluetooth
	Data usage
	Display
	Notifications
	Sound
	Apps
	Screenshot Setting
	Storage
	Battery
	Memory
	Users
	Location
	Security
	Accounts
	Google
	Languages & input
	Backup & reset
	Date & time



Status of Menu Bar

1. Click "▽" in the menu to hide the Home Button (Fig. 1).

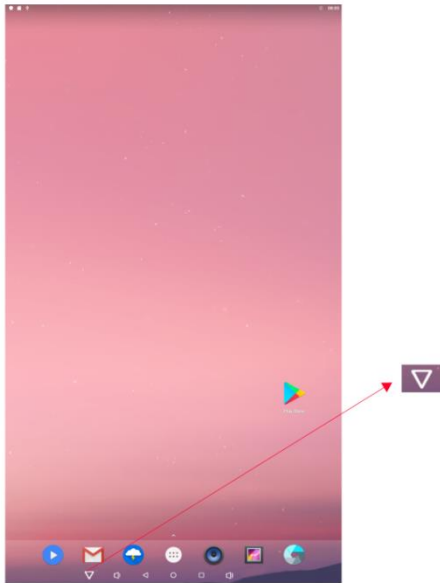

Fig. 1

DiViEx APP Introduction

System requirements:

Step 1: Before using the APP, make sure your device meets or exceeds the following system requirements:

CPU	RK3288
ROM	16GB
Operating system	Android 7.1

How to upload media files :

Step 2: Plug in your USB drive to the computer. Open the drive in Windows Explorer and create a new folder, rename it "MediaFolder". As shown below:

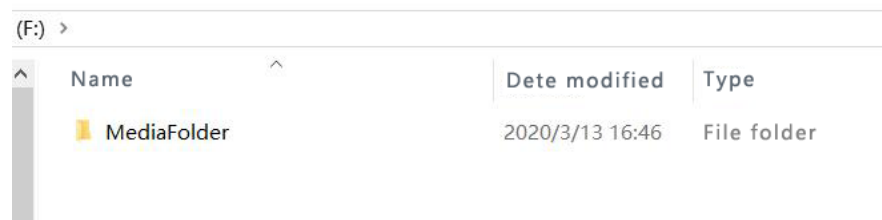

Open "MediaFolder", create 3 subfolders, and change their names to "Images", "Videos", "Music".

Copy the media files to be displayed in the slideshow and paste to the appropriate new folder "Images" or "Videos". Copy and paste music files to "Music" folder.



Supported Media Format:

Image	JPG/JPEG/BMP/PNG
Video	MPEG1/MPEG2/MPEG4/H.264/H.265/WMV/MKV/TS/flv
Music	AAC/MP3/AMR/OGG/PCM

Step 3: Plug the USB drive into the device and click the DiViEx APP.

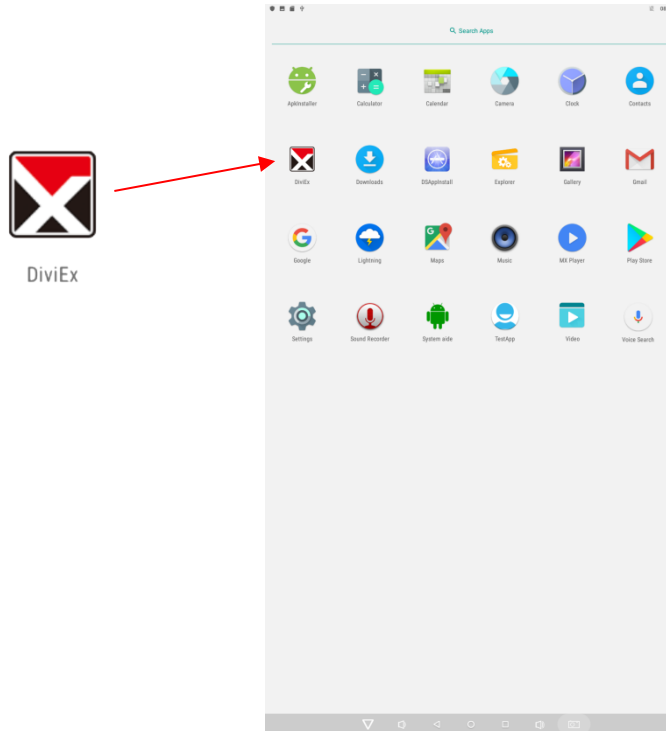

Step 4: When the screen shows "Copy finished" after "Usb Disk:", the media files are ready to be displayed.

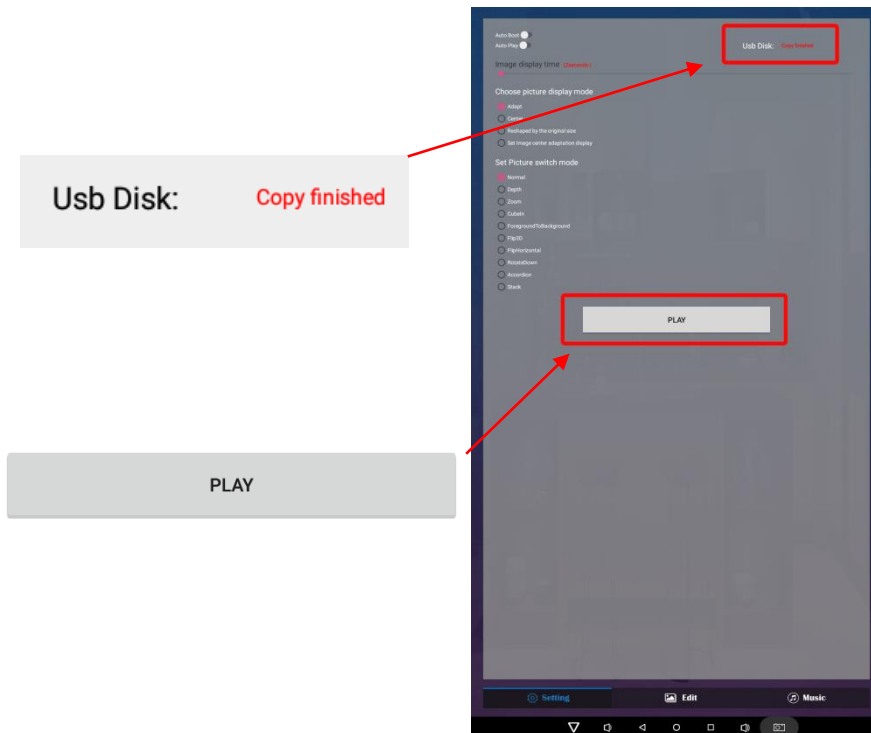

Settings:

1. Set the time each picture is to be shown on the screen by dragging the bar to the desired time.
2. Select how you would like the images to display. Select the desired transition effect between pictures:
 - **Auto Boot**
DiViEX APP will automatic open when the digital signage is turned on.
 - **Auto Play**
DiViEX APP will automatic play the slideshow when it is opened.
 - **Choose Picture display mode**
Check a fit option how you want the pictures to be displayed.
 - **Set Picture switch mode**
Choose an animation option to set the fade in and fade out effects.

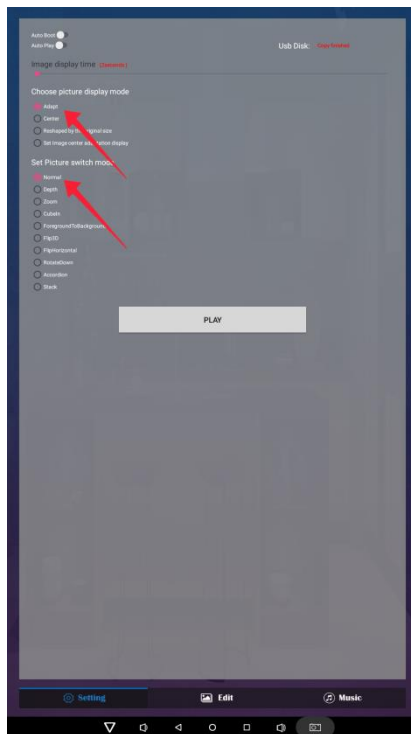

Edit picture:

This function shows all pictures, you can edit all pictures, and remove it.

- **Crop**
There are four corner handles and four border handles to crop the picture. Click and drag a handle to reshape the image to any size you need.
- **Filter**
You can browse and try different filters in the filter gallery below the image. The APP support the following filter: AUTO_FIX, BLACK_WHITE, BRIGHTNESS, CONTRAST, CROSS_PROCESS, DOCUMENTARY, DUE_TONE, FILL_LIGHT, FISH_EYE, FLIP_HORIZONTAL, FILP_VERTICAL, GRAIN, GRAY_SCALE, LOMISH, NEGATIVE, PSTERIZE, ROTATE, SATURATE, SEPIA, SHARPEN, TEMPERATURE, TINT, VIGNETTE.
- **Reset**
Click "Reset" to remove all the editing you applied to the image.
- **Save** 
Click the icon to save the edited image as a new image.

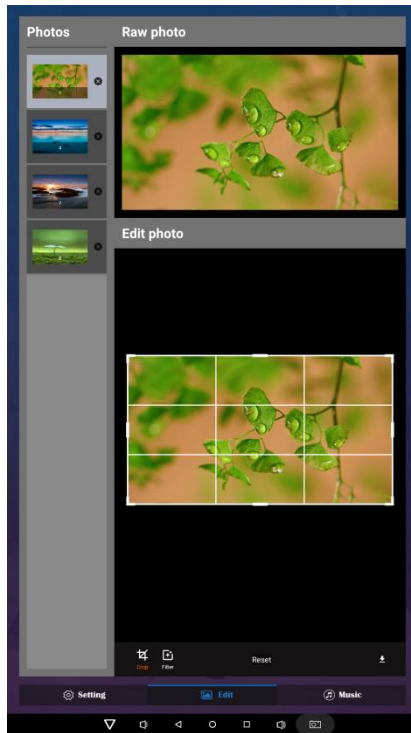

- **Image deletion**

Click "✕" to delete unwanted pictures

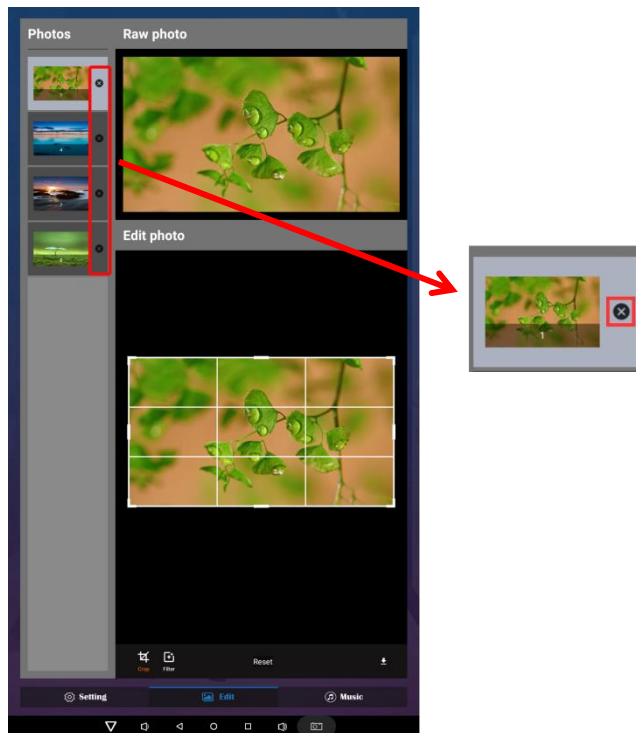

Music:

List all music files in the Playlist library

- Add music to "Playing List Music" (Background music) from "Playlist Library".
Click "right arrow", music title will show in the "Playlist Music" on the right.

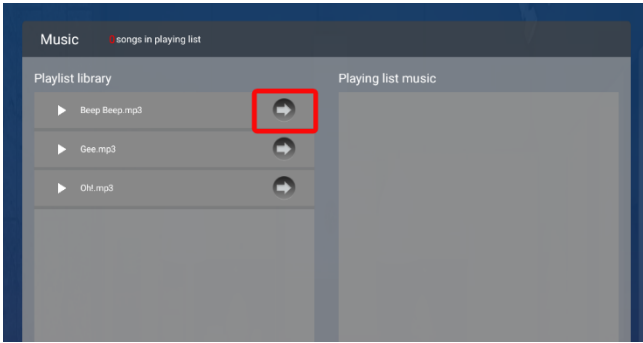

- To remove background music from the playlist, click the left arrow in the playlist

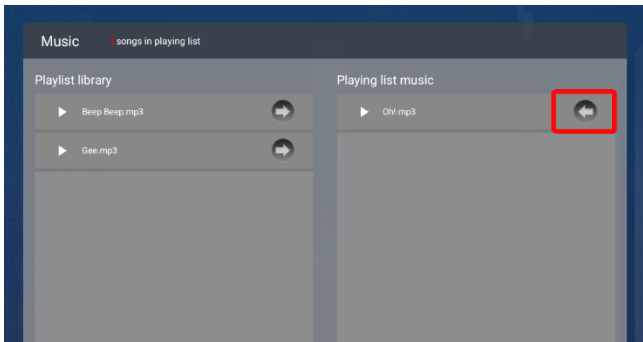

Factory Reset:

1. Go to Settings, then click "Backup & reset" (Fig. 1)
2. Click "Factory data reset" (Fig. 2)
3. Choose "Erase SD card", then click "RESET DEVICE" to get the unit to default settings. (Fig. 3)

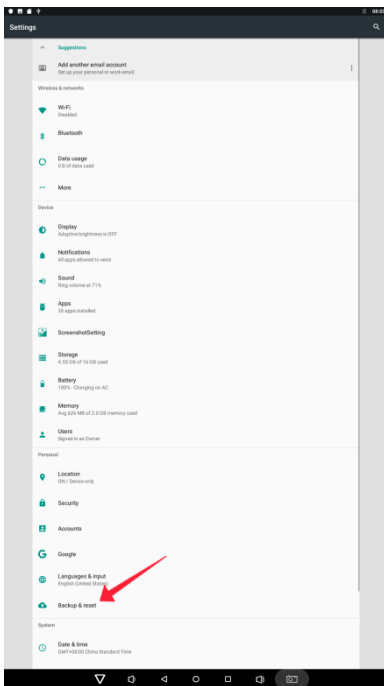

Fig. 1

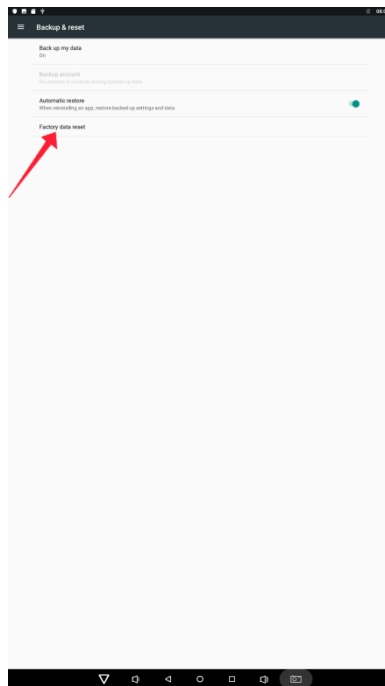

Fig. 2

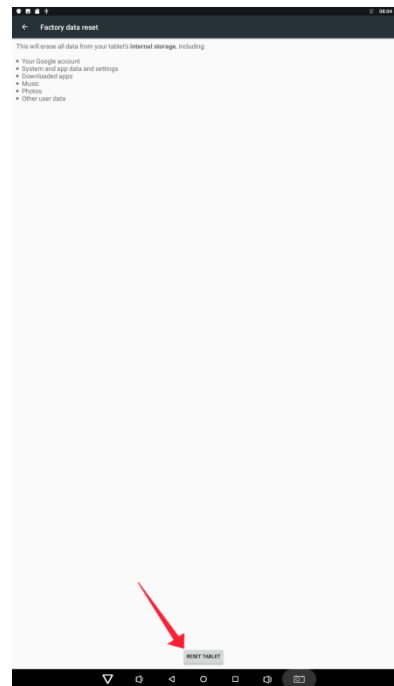

Fig. 3

Screen Rotation:

1. Click the Main Apps button “

Fig. 1

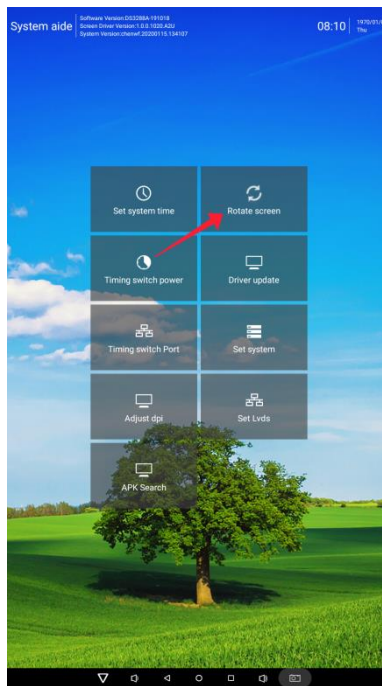

Fig. 2

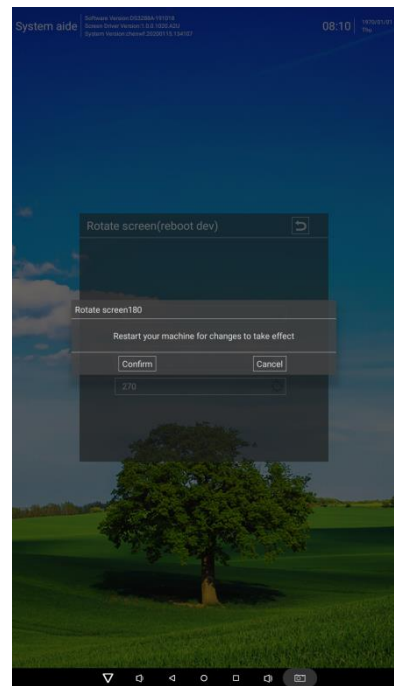

Fig. 3

Choose System Language:

1. Get into Settings, then click “Language & input” (Fig. 1)
2. Click “Languages”, then click “Add a language” (Fig. 3)
3. You can add the required system language (Fig. 4)
4. Drag the system language you just added up to the front(Fig. 5)

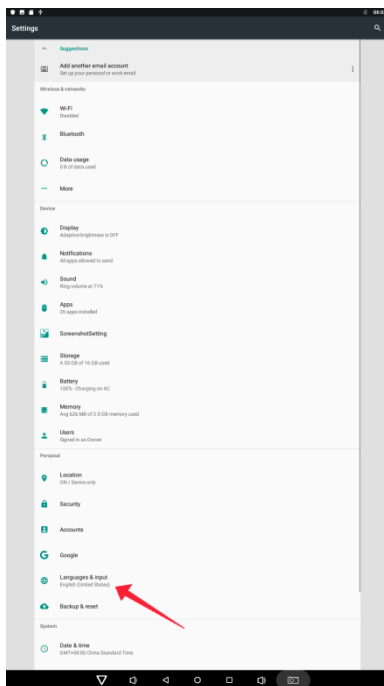

Fig. 1

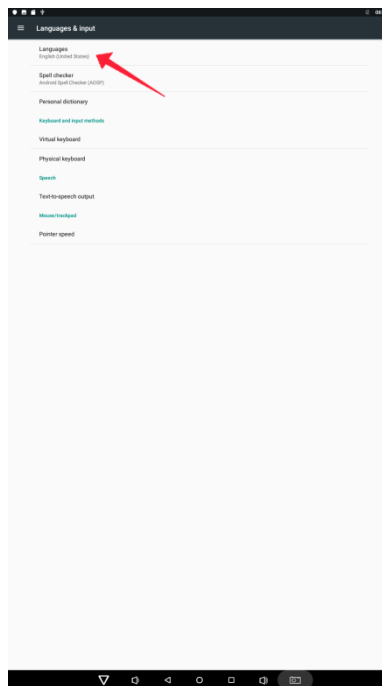

Fig. 2

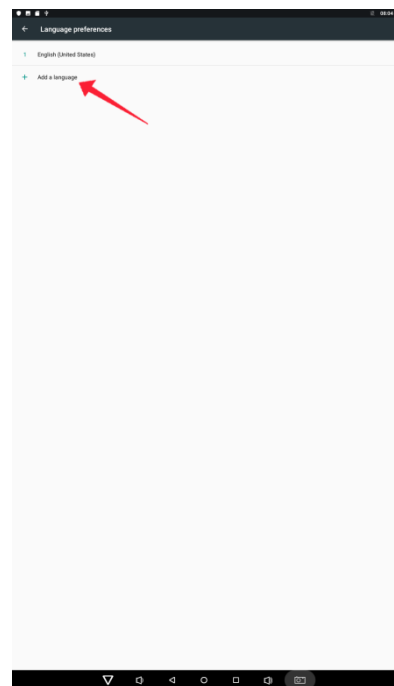

Fig. 3

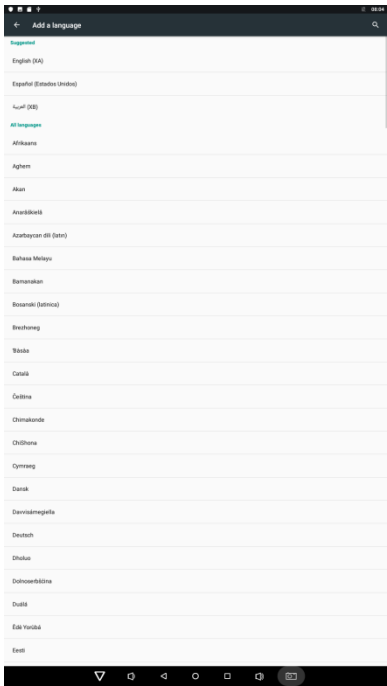

Fig. 4

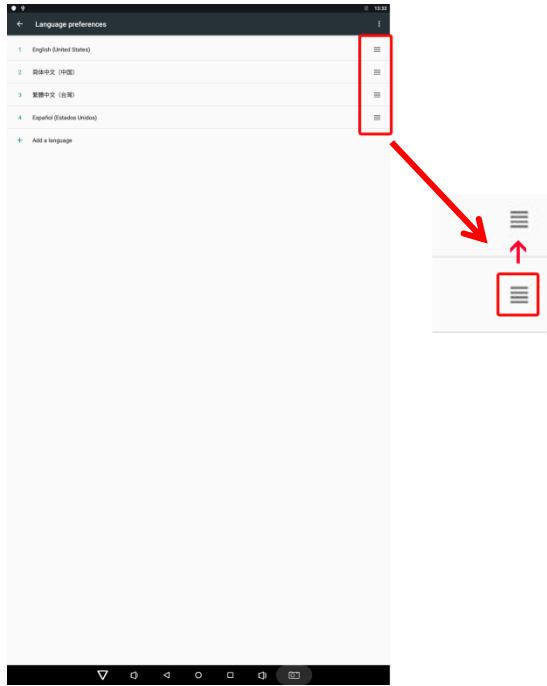

Fig. 5



Technical Specifications

	ITEM	SPECIFICATION
Panel	LCD size	55"
	Light source	LED backlight
	Resolution	1920*1080 (pixels)
	Brightness (typ.)/(min)	400cd/m ² (typ.)
	Contrast (typ.)	1200:1 (typ.)
	Response (ms)	10ms (typ.)
	Pixel pitch	0.63 (H) mm * 0.63 (V) mm
	Refresh rate	60Hz
	Viewing angle	178° (H)/178° (V)
	Color saturation	70%
	Viewable area	1209.6(H) mm * 680.4(V) mm
	Chromaticness	16.7M
	Power supply	Voltage
Power Consumption		≤150W
Environment	Operating temperature (°C)	0~40°C
	Storage temperature (°C)	-10~60°C
	Storage humidity	10~60% RH Non-condensing
	Operating humidity	20~80% RH Non-condensing
	Maximum operating time (hrs/day)	18 hours
Functions	Operating system	Android 7.1
	Processor	RK3288, quad-core
	RAM	2G
	Built-in memory	16G
	Decoding resolution	1080P UHD compatible
	Playback mode	Support loop, inter-cut, timer, shim, etc.
	Touch support	IR Touch, 10 points

Functions	Supported Video Files	AVI, MPEG4, WMV, MKV, FLV, MP4, MOV
	Supported Photo Files	JPG, JPEG, BMP, PNG, GIF
	Audio output, supported files	Left and right audio channel, MP3
	RTC (real-time clock)	Yes
	Schedule power on/off	Yes
	System update	USB compatible
	App installation	Support download and installation
I/O interfaces	TF	N/A
	Ethernet (RJ45)	1
	HDMI	1
	VGA	N/A
	Headset	N/A
	USB	3
	SIM	N/A
Structure	Net weight	69kg
	Gross weight	88kg
	Unit dimensions (W*D*H)	810*70*1980mm
	Package dimensions (W*D*H)	≈2160*240*950mm
	Shell material	Aluminum profile/sheet metal
	Shell color	Silver/White
Language	OSD	English/Simplified Chinese

Troubleshooting the Digital Signs - DGSNFSNT43, DGSNFSNT55, DGSNFSSTCH43, DGSNFSSTCH55

Issue	Probable Cause	Solutions
<ul style="list-style-type: none"> ● No picture or sound 	<ul style="list-style-type: none"> ➤ Unit not plugged into wall outlet ➤ Power cord not properly connected to the terminal on the back of the unit. ➤ Unit not powered on ➤ Wall outlet not working 	<ul style="list-style-type: none"> □ Check that the unit is plugged into wall outlet. □ Confirm that the power cord is connected to the terminal on the back of the unit. □ Turn the on/off toggle switch located on the back of the unit, lower center, to the “on” position. □ Unplug unit, wait 20 seconds, plug unit back into outlet and try again. □ Make sure that outlet is working by plugging in a different electrical device. ❖ If all of the above have been checked and the issue is not resolved, contact a customer service representative.
<ul style="list-style-type: none"> ● No sound (but picture is working) 	<ul style="list-style-type: none"> ➤ Volume not adjusted on the remote control. ➤ Content/Video does not have sound. ➤ Content format is not compatible. ➤ Speakers do not work. 	<ul style="list-style-type: none"> □ Adjust volume using the remote control □ Confirm content is one of the following compatible formats: AVI, MPEG4, WMV, MKV, flv, MP3, MP4, MOV. □ If unit is connected to Wi-Fi, go to YouTube and play video that has sound □ Unplug unit, wait 20 seconds, plug unit back into outlet and try again. □ Try playing the content on a different device (smart phone, computer or tablet) ❖ If all of the above have been checked and the issue is not resolved, contact a customer service representative.
<ul style="list-style-type: none"> ● No picture (but sound is working) 	<ul style="list-style-type: none"> ➤ Content file damaged. ➤ Content format is not compatible. ➤ Screen damaged or defective. 	<ul style="list-style-type: none"> □ Confirm content is one of the following compatible formats: AVI, MPEG4, WMV, MKV, flv, MP3, MP4, MOV. □ Try playing the content on a different device (smart phone, computer or tablet) □ Unplug unit, wait 20 seconds, plug unit back into outlet and try again. ❖ If all of the above have been checked and the issue is not resolved, contact a customer service representative.
<ul style="list-style-type: none"> ● Remote control not working 	<ul style="list-style-type: none"> ➤ Batteries not inserted properly. ➤ Batteries are dead. ➤ Standing too close or too far from the unit. 	<ul style="list-style-type: none"> □ Check that battery is inserted properly with positive and negative orientation. □ Insert new batteries. □ Stand within 1 foot of the front of the unit and point the remote directly at the sensor (green dot) ❖ If all of the above have been checked and the issue is not resolved, contact a customer service representative.

<ul style="list-style-type: none"> ● No Wi-Fi signal 	<ul style="list-style-type: none"> ➤ Wi-Fi is not turned on in product settings. ➤ Wi-Fi is not connected to a network ➤ Low or no signal from the router ➤ Antenna is missing or not pointed upward. ➤ Damaged PC board 	<ul style="list-style-type: none"> □ Check that Wi-Fi is turned on in settings <ul style="list-style-type: none"> ○ Click the settings icon from the Android home screen.  ○ Click “Wi-Fi”. ○ Click the on/off icon in the upper right hand corner to turn on Wi-Fi.  ○ “On” will appear on the upper left hand side. ○ Then select your Wi-Fi network □ Confirm that the antenna is in place and pointed upward. □ Check that other devices are receiving the signal. <ul style="list-style-type: none"> ○ If other devices are not receiving the Wi-Fi signal, please contact your internet service provider. □ Unplug or reset the router and wait for 20 seconds. Restart the router and check. ❖ If all of the above have been checked and the issue is not resolved, contact a customer service representative.
<ul style="list-style-type: none"> ● Parts missing or Damaged 	<ul style="list-style-type: none"> ➤ Parts missed during manufacturing. (No charge for replacements) ➤ Parts lost or damaged by the customer. (There is charge for replacements) 	<ul style="list-style-type: none"> ❖ Contact a customer service representative.
<ul style="list-style-type: none"> ● Having problems with installing software or getting content to play 	<ul style="list-style-type: none"> ➤ Did you purchase the DisplayIt!Xpress software from Displays2go? ➤ Did the customer purchase or downloaded another 3rd party software onto the product? 	<ul style="list-style-type: none"> □ If you purchased DisplayIt!Xpress software from Displays2go or from Best Wave directly, please contact Best Wave at support@bestwave.com or (480)368-8900 ext. 2 □ If you purchased or downloaded another 3rd party software onto the product, please contact the 3rd party software company’s customer support for assistance.
<ul style="list-style-type: none"> ● Cannot upload content 	<ul style="list-style-type: none"> ➤ Content format is not compatible. ➤ Content files are too large. ➤ Port being used is defective ➤ App being used to play content is defective. ➤ Android board is defective. 	<ul style="list-style-type: none"> □ Confirm content is one of the following compatible formats: AVI, MPEG4, WMV, MKV, flv, MP3, MP4, MOV. □ Confirm file size is less than available space. ❖ If all of the above have been checked and the issue is not resolved, contact a customer service representative.

<ul style="list-style-type: none"> ● Issues using pre-installed apps 	<ul style="list-style-type: none"> ➤ Mistake in storing content to NAND Flash (shown on pg. 11) ➤ App is defective ➤ Android board is defective. 	<ul style="list-style-type: none"> □ SlideShow App steps Explorer > Select USB > Select Multi > highlight files > Editor > Select Copy > Home > NAND > MediaFolder > Images> Editor > Paste <ul style="list-style-type: none"> ○ Open SlideShow app and select desired transitions, slide time and looping > Play □ MX Player steps > Follow same steps as SlideShow App > MediaFolder > Video > Editor > Paste. <ul style="list-style-type: none"> ○ Open MX Player and select video to play. ○ Loop video: While the video is playing, click on the video and there should be 3 dots in the top right corner. Click on the 3 dots > play > check desired Loop option □ If all of the above have been checked and the issue is not resolved, contact a customer service representative.
-------------------------------------------------------------------------------------	-----------------------------------------------------------------------------------------------------------------------------------------------------------------------------------	------------------------------------------------------------------------------------------------------------------------------------------------------------------------------------------------------------------------------------------------------------------------------------------------------------------------------------------------------------------------------------------------------------------------------------------------------------------------------------------------------------------------------------------------------------------------------------------------------------------------------------------------------------------------------------------------------------------------------------------------------------------------------------------------------------------------------------------------------------------------------------------------------------------------------------

Cleaning and Maintenance

1. Avoid strong vibration or impact on the product.
2. Keep the product dry to avoid possible damage by moisture.
3. Don't place the product under direct sunlight which may shorten the service life of the screen.
4. Clean screen and product by using a glass cleaner.
5. If the product will not be used for a long time, pull out the power cord to prevent the internal short circuit or other potential dangers.

Names and Contents of Toxic and Hazardous Substances or Elements in the Product

Part name	Toxic and hazardous substances or elements					
	Pb	Hg	Cd	Cr ⁶⁺	PBB	PBDE
Display		○	○	○	○	○
Shell	○	○	○	○	×	×
Circuit board assembly *		○	○	○	○	○
Wires	○	○	○	○	○	○
Metal parts	○	○	○	○	○	○
Packaging materials*	○	○	○	○	○	○
Remote control		○	○	○	○	○
Speaker		○	○	○	○	○
Accessories*	○	○	○	○	○	○

*: Circuit board assembly includes PCB and the electronic elements thereof;

Packaging materials include packaging box, styrofoam, etc.;

Other accessories include instruction manual.

○: the content of the toxic and hazardous substances or elements in the part is lower than the limit specified in GB/T 26572-2011 standard.

×: the content of the toxic and hazardous substances or elements in the part is higher than the limit specified in GB/T 26572-2011 standard.

The table shows that the machine contains harmful substances inside. The data is provided by material suppliers and verified by the company according to the material type. Some materials contain harmful substances that can't be replaced in present technology. We are dedicated to improving this.

The EFUP of the product is ten years. The pollution control label is shown on the right. 

The EFUP is valid only when the user operates in the normal conditions specified in the manual herein.

Waste Electrical and Electronic Products Recycling and Disposal Regulations

To protect the earth, if you do not need this product or its service life expires, please abide by your local ***Waste Electrical and Electronic Products Recycling and Disposal Regulations*** or send it to qualified local manufacture for recycling.

FCC Compliance Notice

FCC ID: 2ASCB-DGSN71

This device complies with Part 15 of the FCC Rules. Operation is subject to the following two conditions:

- (1) this device may not cause harmful interference, and
- (2) this device must accept any interference received, including interference that may cause undesired operation.

Any changes/modifications to this equipment not approved by the party responsible for compliance could void the user's authority to operate the equipment.

NOTE: This equipment has been tested and found to comply with the limits for a Class B digital device, pursuant to part 15 of the FCC Rules. These limits are designed to provide reasonable protection against harmful interference in a residential installation. This equipment generates, uses and can radiate radio frequency energy and, if not installed and used in accordance with the instructions, may cause harmful interference to radio communications. However, there is no guarantee that interference will not occur in a particular installation. If this equipment does cause harmful interference to radio or television reception, which can be determined by turning the equipment off and on, the user is encouraged to try to correct the interference by one or more of the following measures:

- Reorient or relocate the receiving antenna.
- Increase the separation between the equipment and receiver.
- Connect the equipment into an outlet on a circuit different from that to which the receiver is connected.
- Consult the dealer or an experienced radio/TV technician for help.

FCC Radiation Exposure Statement:

This equipment complies with FCC radiation exposure limits set forth for an uncontrolled environment. This equipment should be installed and operated with minimum distance 20 cm between the radiator and your body.

This Manual is for reference only and is subject to change without prior notice.